

Product Details

Headrail, dependant on fabric

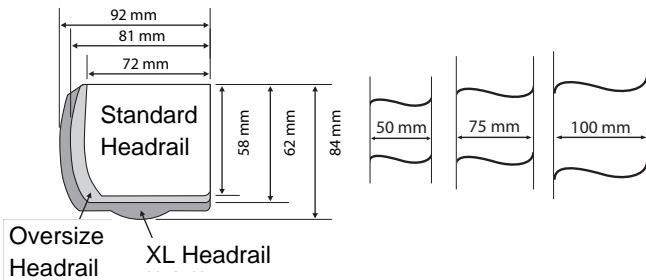

- Head and bottom rail are colour coordinated
- Oversize Headrail is available in 6 colours (0204 / 0155 / 0161 / 4131 / 4355 / 7113)
- XL Headrail is available in 4 colours (0204 / 0155 / 0161 / 4131)
- Silhouette® Shades with slat width 75 mm will always be mounted on Oversize headrail and have 50 mm bottom rail.
- Silhouette® Shades with slat width 100 mm will always be mounted on XL Headrail and have a 65 mm bottom rail.

Size Limits

Fabric width 50 & 75 mm	Width in mm		Drop in mm				Area. in m ²
	Min.	Max.	Min.	Max.**	Max.***	UltraLift™	
Toujours	300*	2400	300	2000	2400	2000	5,8
Naturelle	300*	2400	300	2400	2950	2000	7.2
Originale	300*	2400	300	2400	2950	2400	7.2
Bon Soir	300*	2400	300	2000	2400	2000	4.3

* Smaller than 600mm with hold down brackets supplied as standard. Blinds of this size may not roll up square. The minimum recommendd width for electric op. is 600mm

** Standard Headrail

*** Max. Drop with Oversize Headrail

Fabric Width 100 mm	Width in mm		Drop in mm		Area. in m ²
	Min.	Max.	Min.	Max.	
Originale	300*	2850	300	2950	8.4
Bon Soir	300*	2850	300	2950	8.4

* Smaller than 600mm with hold down brackets supplied as standard. Blinds of this size may not roll up square.

Mounting Details

Recess allowance

- Drop minus 5 mm
- Width minus 5 mm

Clearances with 2 products butted together

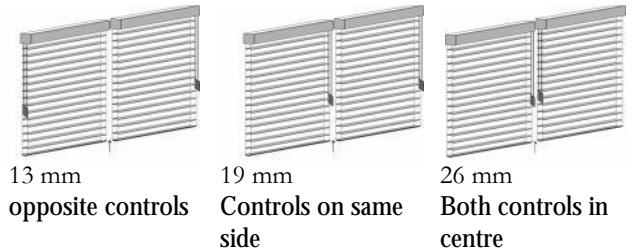

- Slat alignment between adjacent shades can vary in drop by the following allowances:
 - max. 5 mm / when total width of 2 blinds < 2600 mm
 - max. 10 mm / when total width of 2 blinds > 2600 mm
- The total drop can vary up to 3 mm

Mounting in Recess

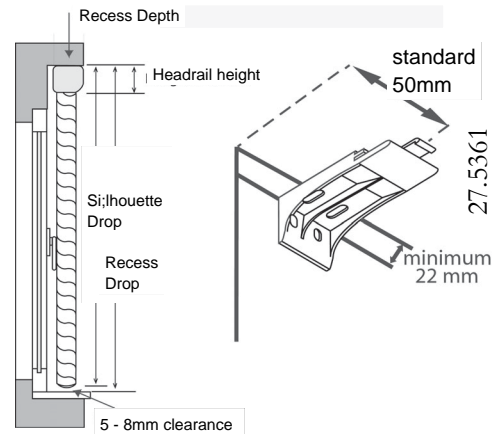

Recess:

- Standard Headrail 73 mm
- Oversize Headrail 83 mm
- XL Headrail 93 mm

Mounting on Face.

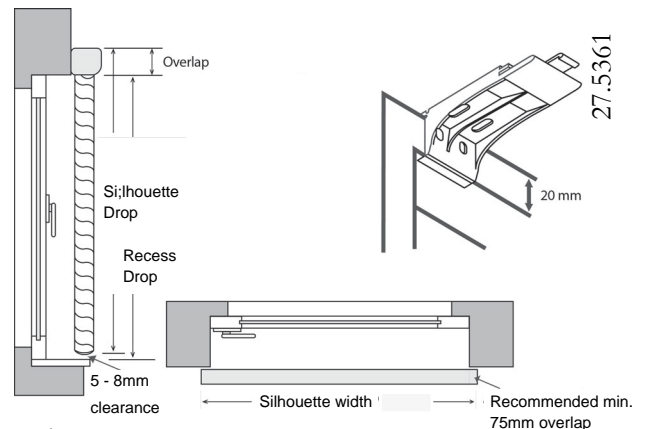

Overlap:

- Standard Headrail 60 mm
- Oversize Headrail 65 mm
- XL Headrail 81 mm



Silhouette® Shades

Bracket Qty.

Product Width	Bracket Qty.
Less than 800 mm	2
800 - 1600 mm	3
1600 - 2400 mm	4
2400 - 2850 mm	5

Spacer block

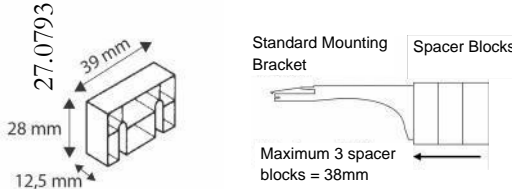

Extension Bracket

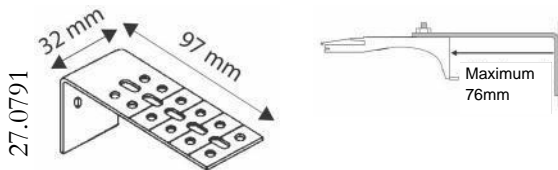

- Each 800 mm add 1 bracket

Operation

Endless cord with cord weight

Product drop (in mm)	Length cordloop (in mm)
300 - 1000	600 (white)
1000 - 1500	900
1500 - 2100	1200
2100 - 2400	1500
2400 - 2950	1800 (white)

- Alternative cordlengths: 2100, 2400, 2700, 3000, 3300 and 3600 mm (colour white)
- Cordlength: 900, 1200 and 1500 mm (Colour coordinated)

UltraLift™

- UltraLift™ option is NOT available for XL Headrail
- Standard Cord Length: 2/3 of product drop
Alternative cord lengths: minimum 300 mm, maximum 2x product drop
- NOT available for 100 mm slat width



PowerRise™ (electric with batteries)

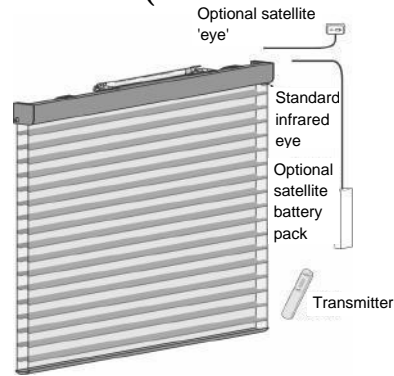

- Electric operation with batteries operated by an infra-red transmitter and headrail mounted battery pack and infra red eye
- Option of 2 channels
- NOT in combination with 100 mm slat width
- Optional externally mounted infrared eye and battery-holder with cable lengths of 500, 1200 or 2400 mm
- NEW Option of Battery Powered RTS radio control motor
Uses same options of battery holders, but without requirements for receiver 'eyes'. Size limits as per manual operation.

Maximum Drop PowerRise™ using standard headrail

Width	<1370	1520	1680	1830	1980	2130	2290	2400
Originale	2400	2400	2400	2400	2134	1676	1372	1067
Bon Soir	1981	1981	1981	1981	1676	1372	1067	0914
Toujour	1981	1829	1524	1219	1067	0914	0610	-
Naturelle	1981	1981	1981	1981	1676	1372	1067	0914

Maximum Drop PowerRise™ using Oversize headrail

Width	<1220	1370	1520	1680	1830	1980	2130	2290	2440
Originale	2950	2950	2950	2950	2591	2134	1676	1372	1067
Bon Soir	2400	2950	2400	1981	1981	1676	1372	1067	0914
Toujour	2400	2286	1829	1524	1219	1067	0914	0610	-
Naturelle	2400	2400	1981	1981	1981	1676	1372	1067	0914

24v hardwired motor

- NOT in combination with 100 mm slat width
- Variety of control options available from switch to remote
Please see Motorisation Price lists for details on options.



Options

Top Cover Strip

Top view without cover strip

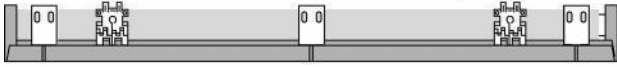

Top view with full cover strip - mounting outside recess



Top view with part cover strip - part fitted in recess

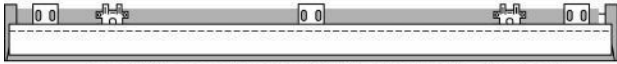

Back Cover Strip

Minimum recess depth + 7mm
to sizes stated on page 1

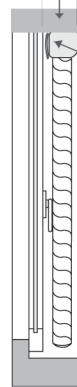

Headrail Depth
as stated on Page 1

Back cover strip at extra cost per metre



10.1014



27.5364

Bottom rail hold down brackets

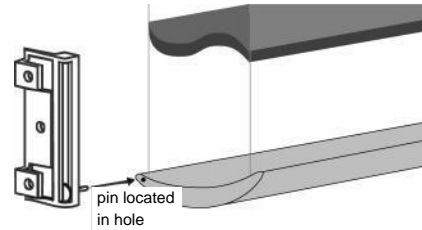

- For mounting on doors or draughty windows
- For raising the product should be released from the hold down brackets
- Supplied as standard when the width of the Shade is less than 600 mm

Silver Oversize Headrail/ bottom rail (colour 7113)



- Available with 50 & 75 mm slat width (at surcharge)
- Standard without surcharge with fabric colour 3901 (Silver Metal)











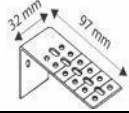

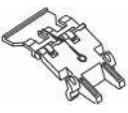
Silhouette® Shades

Summary Points

- Silhouette® Shades with slat width 75 mm will always be mounted on an Oversize headrail
- Silhouette® Shades with slat width 75 mm will always be mounted with a 50 mm bottom rail
- 100 mm only available with endless cord operation only
- UltraLift™ Standard cord length 300 mm

Parts list

Silhouette® Shades		Part no.
	Standard mounting bracket	27.5361
	Extension bracket	27.0791
	Spacer block	27.0793
	Hold down bracket	27.0795
	Limit stop standard headrail	27.0451
	Limit stop Oversize headrail	27.1451
	Limit stop XL headrail	27.4451
	Top cover strip (per meter)	27.0771
	Back Cover strip (per meter)	10.1014
	Back coverstrip bracket	27.5364
	Satellite eye + 500 mm cable	27.8581
	Satellite eye + 1200 mm cable	27.8582
	Satellite eye + 2400 mm cable	27.8583
	External battery pack + 500 mm cable	27.8591
	External battery pack + 1200 mm cable	27.8592
	External battery pack + 2400 mm cable	27.8593
	Cord connector UltraLift™	15.6617

Silhouette® Shades		Bestelnr.
	Transmitter PowerRise™	27.8531

